

Experimental Analysis of the Line-Side Interphase Transformer Magnetizing Currents in Three-Phase Output Voltage Type Rectifiers

Dejana Čučak, Predrag Pejović, and Johann W. Kolar

Abstract—Magnetizing currents of a line side interphase transformer applied in a three phase twelve pulse voltage output type rectifiers are analyzed. Waveforms of the transformer voltages are derived. It is shown that fluxes of the core limbs contain a significant zero sequence component, resulting in a stray flux and high magnetizing currents. Application of three single phase cores is proposed. The results are experimentally verified.

Index Terms—AC-DC power conversion, converters, harmonic distortion, power conversion harmonics, power quality, rectifiers.

I. INTRODUCTION

A MAGNETIC device applied in the three phase twelve pulse voltage output type rectifier shown in Fig. 1 is analyzed in this paper. The device is designated by a dotted rectangle in Fig. 1, and it is named line side interphase transformer [1]. Three phase rectifiers of the output voltage type are analyzed in [1–4]. They are characterized by simple and robust construction, requiring only passive elements. Analysis of a voltage loaded six pulse rectifier applying sinusoidal approximation is given in [5]. The analysis applies for the continuous conduction mode. In the case resistive losses can be neglected, an exact solution for the rectifier model is presented in [6]. The analyses of [5, 6] are extended for the twelve pulse output voltage type rectifiers in [7]. Experimental verification of the sinusoidal approximation approach is given in [8].

The line-side interphase transformer input voltages v_{Tk} , $k \in \{1, 2, 3\}$, in the continuous conduction mode have twelve-pulse waveforms, obtained as linear combinations of the output voltages v_{Ak} and v_{Bk} . To obtain proper twelve-pulse voltage waveforms, the line-side interphase transformer turns ratio should be set to $p = (\sqrt{3} - 1)/2 \approx 0.366$ [1]. The line-side interphase transformer output currents are i_{Ak} and i_{Bk} , while the input currents are i_k , $k \in \{1, 2, 3\}$.

Goal of this paper is to determine magnetizing currents of

the line-side interphase transformer in the continuous

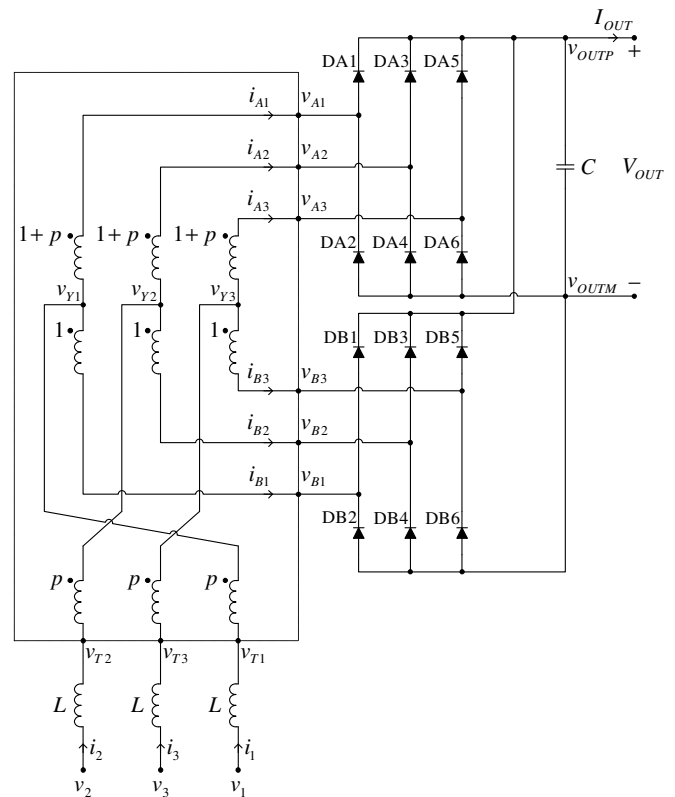

Fig. 1. The rectifier.

conduction mode of the rectifier, and to analyze how does the transformer construction affect the magnetizing currents.

II. THE WAVEFORMS

It is assumed that the rectifier is supplied by an undistorted symmetrical three phase voltage system

$$v_k = V_m \sin\left(\omega t - (k-1)\frac{2\pi}{3}\right) \quad (1)$$

for $k \in \{1, 2, 3\}$. The voltage system does not contain the zero sequence component since

$$v_1 + v_2 + v_3 = 0. \quad (2)$$

The rectifier is connected to the mains as a three wire system, resulting in

$$i_1 + i_2 + i_3 = 0 \quad (3)$$

D. Čučak and P. Pejović are with the University of Belgrade, Faculty of Electrical Engineering, Belgrade, Serbia (e-mail: peja@etf.rs).

J. W. Kolar is with Swiss Federal Institute of Technology, Zürich, Switzerland.

according to Kirchhoff's current law. The line side interphase transformer input voltages are given by

$$v_{Tk} = v_k - L \frac{di_k}{dt}. \quad (4)$$

According to (2) and (3), this provides

$$v_{T1} + v_{T2} + v_{T3} = 0 \quad (5)$$

which is used to determine v_{OUTP} and v_{OUTM} .

It is assumed that capacitance of the filtering capacitor is large, resulting in negligible output voltage ripple. In that case, the output voltage

$$V_{OUT} = v_{OUTP} - v_{OUTM} \quad (6)$$

is assumed as constant.

The sinusoidal approximation [7, 8] assumes currents of the inductors as sinusoidal, specified by

$$i_k = I_m \sin\left(\omega t - \phi - (k-1)\frac{2\pi}{3}\right) \quad (7)$$

where I_m is the input current amplitude, and ϕ is the phase lagging of the input currents with regard to corresponding phase voltages. Values for both of the parameters are determined applying the sinusoidal approximation analysis [7, 8].

According to the equations that characterize the line side interphase transformer [7, 8], its output currents are given by

$$i_{Ak} = \frac{\sqrt{3}-1}{\sqrt{2}} I_m \sin\left(\omega t - \phi + \frac{\pi}{12} - (k-1)\frac{2\pi}{3}\right) \quad (8)$$

and

$$i_{Bk} = \frac{\sqrt{3}-1}{\sqrt{2}} I_m \sin\left(\omega t - \phi - \frac{\pi}{12} - (k-1)\frac{2\pi}{3}\right). \quad (9)$$

Waveforms of i_1 , i_{A1} , and i_{B1} for $\phi = 45^\circ$ are given in Fig. 2.

Polarity of the line side interphase transformer output currents and determine states of the diodes in the diode bridges as

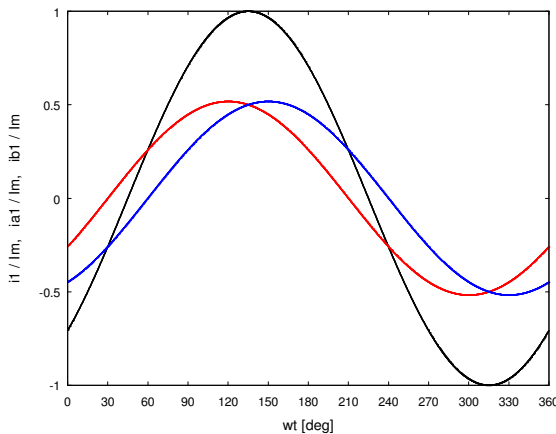

Fig. 2. Waveforms of i_1 (black), i_{A1} (red) and i_{B1} (blue).

$$DA_{2k-1} = \begin{cases} 1, & \text{if } i_{Ak} > 0 \\ 0, & \text{if } i_{Ak} < 0 \end{cases} \quad (10)$$

$$DA_{2k} = \begin{cases} 1, & \text{if } i_{Ak} < 0 \\ 0, & \text{if } i_{Ak} > 0 \end{cases} = 1 - DA_{2k-1} \quad (11)$$

$$DB_{2k-1} = \begin{cases} 1, & \text{if } i_{Bk} > 0 \\ 0, & \text{if } i_{Bk} < 0 \end{cases} \quad (12)$$

and

$$DB_{2k} = \begin{cases} 1, & \text{if } i_{Bk} < 0 \\ 0, & \text{if } i_{Bk} > 0 \end{cases} = 1 - DB_{2k-1} \quad (13)$$

for $k \in \{1, 2, 3\}$. At this point, it is convenient to define auxiliary variables that contain numbers of conducting diodes in a certain diode group as

$$DA_{UP} = DA_1 + DA_3 + DA_5 \quad (14)$$

$$DA_{DN} = DA_2 + DA_4 + DA_6 \quad (15)$$

$$DB_{UP} = DB_1 + DB_3 + DB_5 \quad (16)$$

and

$$DB_{DN} = DB_2 + DB_4 + DB_6. \quad (17)$$

In the continuous conduction mode, in each diode bridge and in each time point three diodes are conducting, thus

$$DA_{UP} + DA_{DN} = 3 \quad (18)$$

and

$$DB_{UP} + DB_{DN} = 3. \quad (19)$$

Voltages of the line side interphase transformer output terminals can take only two values, v_{OUTP} and v_{OUTM} , depending on the corresponding output current polarity. In terms of the diode state functions, this is expressed as

$$v_{Ak} = DA_{2k-1}v_{OUTP} + DA_{2k}v_{OUTM} \quad (20)$$

and

$$v_{Bk} = DB_{2k-1}v_{OUTP} + DB_{2k}v_{OUTM}. \quad (21)$$

The line side interphase transformer input voltages are determined by (4) of [8]. Summing up the input terminal voltages and applying (5), the first equation over and is obtained as

$$\left((2 - \sqrt{3})DA_{UP} + (\sqrt{3} - 1)DB_{UP} \right) v_{OUTP} + \left((2 - \sqrt{3})DA_{DN} + (\sqrt{3} - 1)DB_{DN} \right) v_{OUTM} = 0 \quad (22)$$

while the second one is

$$V_{OUT} = v_{OUTP} - v_{OUTM}. \quad (23)$$

As already stated, in the continuous conduction mode, in each diode bridge, in each time point, three diodes are conducting. As a consequence of Kirchhoff's current law, all three of the conducting diodes cannot be from the upper diode group (odd indexed), neither from the lower diode group (even indexed), meaning that at least one diode in each group must be conducting. Thus, for the two diode bridges there is a total of four possible combinations for the numbers of conducting diodes, as summarized in Table I. For each of the combinations there is a solution for the rectifier output terminal voltages, as given in Table I. For the input currents assumed by (7), resulting waveforms of the output terminal voltages are given in Fig. 3.

TABLE I
VALUES OF THE RECTIFIER OUTPUT TERMINAL VOLTAGES

| DA_{UP} | DB_{UP} | v_{OUTP} | v_{OUTM} |
|-----------|-----------|-------------------------------|--------------------------------|
| 1 | 1 | $\frac{2}{3}V_{OUT}$ | $-\frac{1}{3}V_{OUT}$ |
| 1 | 2 | $\frac{3-\sqrt{3}}{3}V_{OUT}$ | $-\frac{\sqrt{3}}{3}V_{OUT}$ |
| 2 | 1 | $\frac{\sqrt{3}}{3}V_{OUT}$ | $-\frac{3-\sqrt{3}}{3}V_{OUT}$ |
| 2 | 2 | $\frac{1}{3}V_{OUT}$ | $-\frac{2}{3}V_{OUT}$ |

After the rectifier output terminal voltages are known, the line-side interphase transformer output terminal voltages are determined according to (20) and (21), and the resulting waveforms for v_{A1} and v_{B1} are shown in Figs. 4 and 5. The line-side interphase transformer output terminal voltages determine the input terminal voltages according to (4) of [8], and the resulting waveform of v_{T1} is shown in Fig. 6, which is

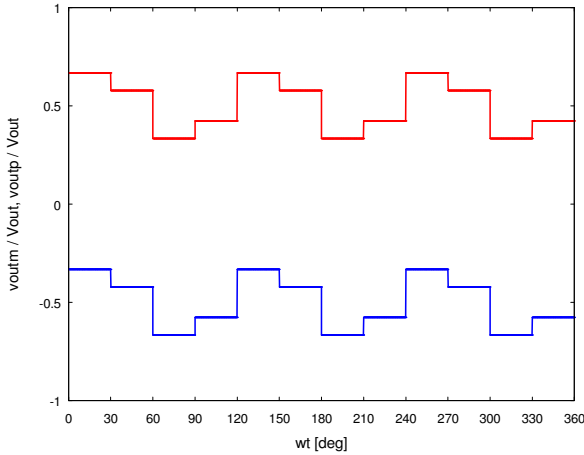

Fig. 3. Waveforms of v_{OUTP} (red) and v_{OUTM} (blue).

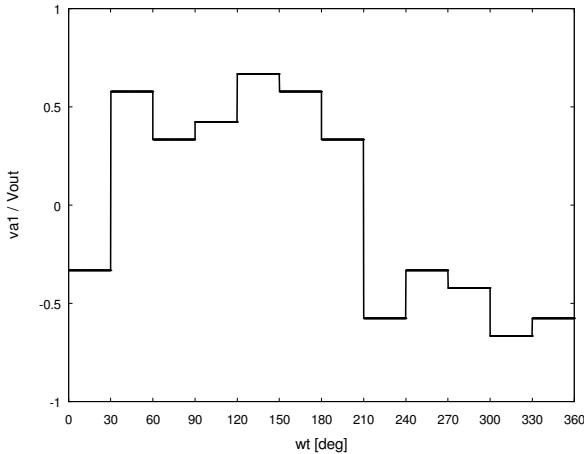

Fig. 4. Waveform of v_{A1} .

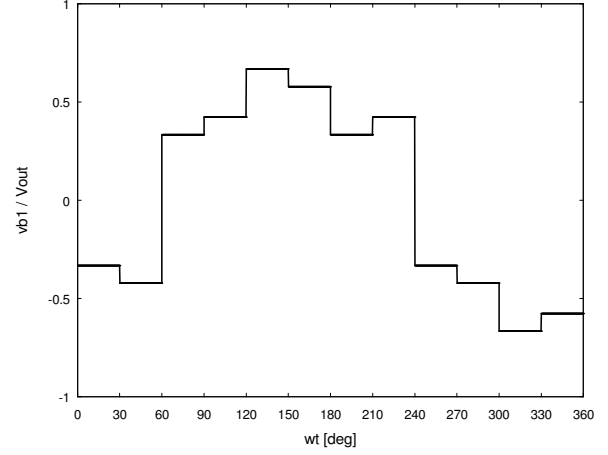

Fig. 5. Waveform of v_{B1} .

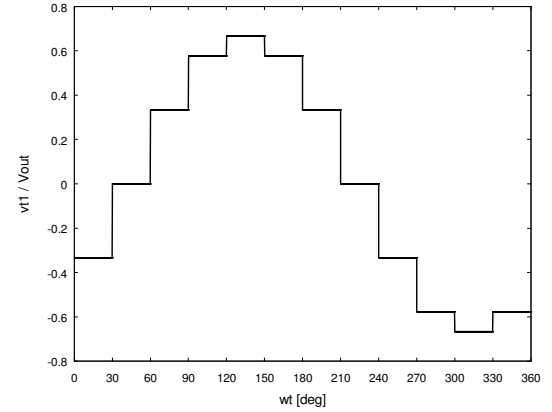

Fig. 6. Waveform of v_{T1} .

used in [7, 8] to complete the sinusoidal approximation based analysis, taking only fundamental harmonics of v_{Tk} into account.

III. MAGNETIZING CURRENTS

Let us assume that the line side interphase transformer is wound around a three phase three limb core that can be modeled by an equivalent magnetic circuit shown in Fig. 7. Limb reluctance is represented by R_m , while the leakage air reluctance is represented by R_{m0} . In practice, $R_{m0} \gg R_m$. Perfect coupling is assumed. The limb fluxes Φ_k are generated by magnetomotive forces F_k , $k \in \{1, 2, 3\}$. It is assumed that the magnetizing current is associated to the windings with the normalized number of turns equal to 1, actual number of turns being n . Thus, the voltages across the magnetizing windings are

$$v_{Mk} = v_{Yk} - v_{Bk} \quad (24)$$

for $k \in \{1, 2, 3\}$. It is convenient to express the magnetizing voltages in terms of v_{Ak} and v_{Bk} determined by (20) and (21) as

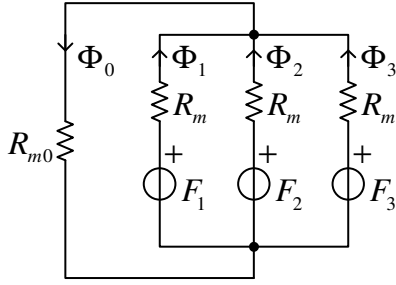

Fig. 7. Equivalent magnetic circuit for the line-side interphase transformer core.

$$v_{Mk} = \frac{v_{Ak} - v_{Bk}}{2 + p} \quad (25)$$

Voltages across the transformer windings are obtained as time derivatives of the corresponding limb fluxes Φ_k multiplied by the corresponding number of turns of the winding, according to Faraday's law. For the magnetizing windings, this results in

$$v_{Mk} = n \frac{d\Phi_k}{dt} \quad (26)$$

Waveforms of all three of the magnetizing voltages are depicted in Fig. 8. These waveforms result in the limb fluxes shown in Fig. 9, being determined applying (26). The system

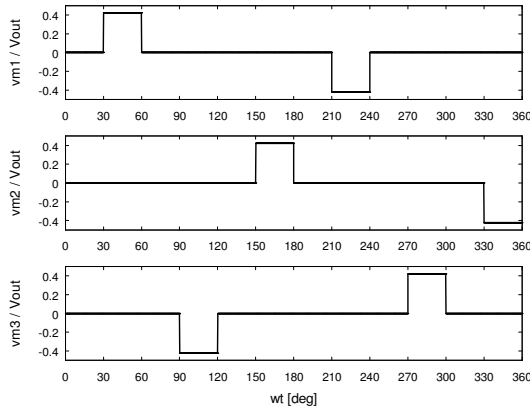

Fig. 8. Voltages across the magnetizing windings.

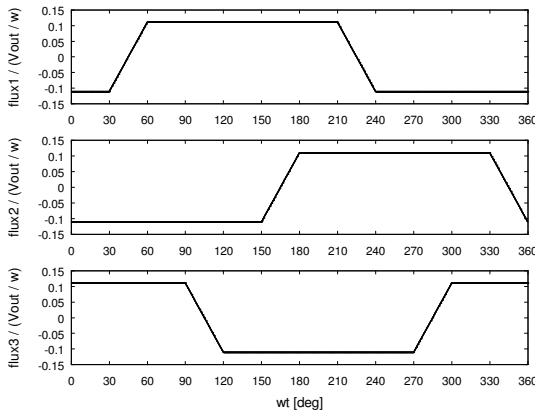

Fig. 9. Waveforms of the limb fluxes.

of magnetizing voltages contains significant zero-sequence component, shown in Fig. 10.

Conservation of flux yields

$$\Phi_0 = \Phi_1 + \Phi_2 + \Phi_3 \quad (27)$$

resulting in a significant stray flux with the waveform shown in Fig. 11. Since $R_m \ll R_{m0}$, magnetomotive force drop across R_m reluctances is negligible in comparison to the magnetomotive force drop across R_{m0} . In this manner, the magnetomotive forces required to magnetize the core are obtained as

$$F_1 = F_2 = F_3 = R_{m0} \Phi_0 \quad (28)$$

The magnetomotive forces are obtained as a product of the magnetizing current and the number of turns of the magnetizing winding,

$$F_k = n i_{Mk} \quad (29)$$

Taking the time derivative of (28) yields

$$\frac{dF_k}{dt} = R_{m0} \frac{d\Phi_0}{dt} \quad (30)$$

Substituting (26), (27) and (29) into (30) provides

$$\frac{di_{Mk}}{dt} = \frac{1}{L_{mzs}} \frac{v_{M1} + v_{M2} + v_{M3}}{3} \quad (31)$$

where

$$L_{mzs} = \frac{n^2}{3R_{m0}} \quad (32)$$

is the zero sequence magnetizing inductance.

According to (31), all three of the magnetizing currents have the same waveform, proportional to the waveform of Φ_0 given in Fig. 11, but with the amplitude equal to

$$I_{m \max} = \frac{\pi}{6(3 + \sqrt{3})} \frac{R_{m0} V_{OUT}}{n \omega} \quad (33)$$

To reduce the magnetizing currents, R_{m0} should be reduced as much as possible. This may be achieved applying five-limb core, core of the shell type, or applying three single-phase cores.

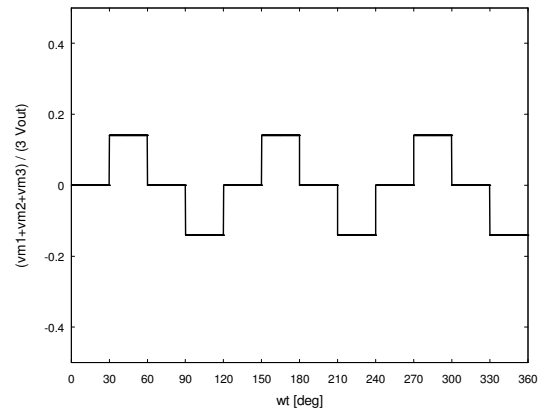

Fig. 10. Zero sequence of the voltages across the magnetizing windings.

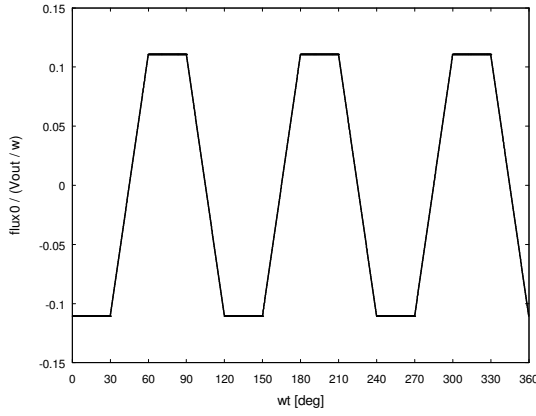

Fig. 11. Waveform of the stray flux.

IV. VA RATING OF THE LINE-SIDE INTERPHASE TRANSFORMER

After the voltages and currents of the line-side interphase transformer are known, its VA rating can be determined. According to [9], in the case three single-phase cores are applied the VA rating of each core is

$$S_{T1} = \frac{6 + 3\sqrt{2} - \sqrt{6}}{1728} \pi^2 P_{OUT} \approx 4.45\% P_{OUT}. \quad (34)$$

It should be underlined here that the result of (34) is applicable only if the rectifier is designed to operate at a fixed operating point, i.e. fixed output power. If the operating point varies, the VA rating is higher, since at low output currents the output voltage is high, resulting in increased flux stress on the core, while at high output currents the flux in the core is reduced, but the RMS values of the currents in the line-side interphase transformer windings are increased. Thus, the core should be dimensioned not to saturate at low output currents, while the windings should be dimensioned not to overheat at high output currents. These requirements cause the VA rating to be higher than specified by (34), the increase being dependent on the operating point variation.

Normalized rated power of the inductors is computed according to [9] as

$$S_L = \frac{1}{4} J_m^2 = \frac{\pi^2}{288(2 - \sqrt{3})} J_{OUT}^2 \quad (35)$$

and it cannot be expressed as a single-variable function of the output power.

V. EXPERIMENTAL RESULTS

To verify the results, two rectifier models were made, one using the line-side interphase transformer with a three-phase core, and the other one with three single-phase cores. The rectifiers were operated with $V_m = 32$ V, and the diagrams were recorded at $I_{OUT} = 5$ A, where the three-phase core provided $V_{OUT} = 20$ V, while the version with single-phase cores provided $V_{OUT} = 27$ V, indicating significantly increased efficiency.

Waveforms of i_{A1} , v_{A1} , i_{A2} , and v_{A2} are shown in Fig. 12 for the three-phase core version, while for the single-phase version the same waveforms are given in Fig. 13. The waveforms of v_{A1} and v_{A2} are in agreement with the predictions of Fig. 4, except for the slight curving caused by the resistive voltage drop on the windings, pronounced in the three-phase core version. Currents i_{A1} and i_{A2} are significantly more distorted in the three-phase case in comparison to the single-phase case. Waveforms of $i_{A1} + i_{A2} + i_{A3}$ and $i_{B1} + i_{B2} + i_{B3}$ that contain the waveform of the magnetizing currents, accompanied by the waveforms of v_{M1} and v_{M2} are shown in Figs. 14 (three-phase core version) and 15 (three single-phase cores version). Comparing the waveforms, it is concluded that in the three-phase version the magnetizing currents are reduced for about 27 times, resulting in reduced ringing currents and losses. The waveforms of v_{M1} and v_{M2} are distorted in comparison to the prediction of Fig. 8 for the resistive voltage drop across the windings, not included in the analysis. The distortion is higher in the three-phase case.

Regardless the fact that losses in the transformer windings were not taken into account in the analysis, the idealized analytical approach successfully predicted relevant behavior

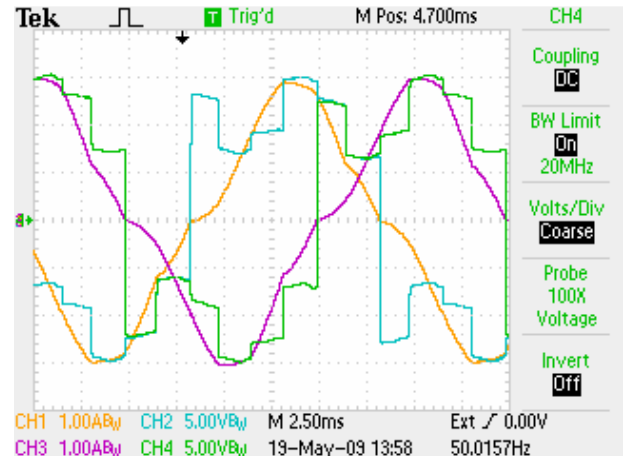
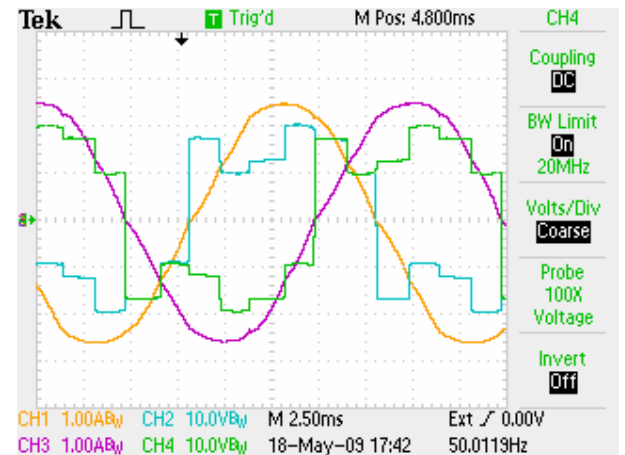
Fig. 12. Waveforms of i_{A1} , v_{A1} , i_{A2} and v_{A2} , three-phase core.Fig. 13. Waveforms of i_{A1} , v_{A1} , i_{A2} and v_{A2} , three single-phase cores.

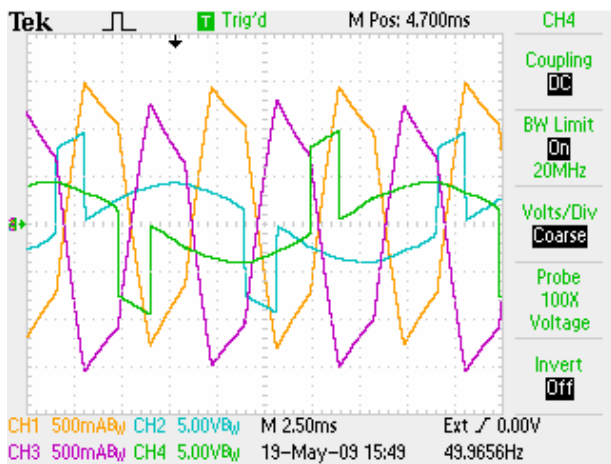

Fig. 14. Waveforms of Σi_A , Σi_B , v_{M1} , v_{M2} , three-phase core.

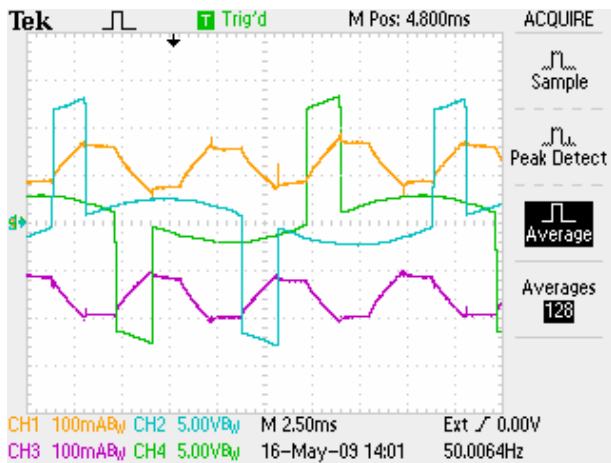

Fig. 15. Waveforms of Σi_A , Σi_B , v_{M1} , v_{M2} , three single-phase cores.

of the converter, including the magnetizing currents.

VI. CONCLUSIONS

Magnetizing currents of the line side interphase transformer in a twelve pulse three phase voltage output type rectifier are analyzed in the paper. Waveforms of the transformer voltages

are derived assuming sinusoidal input currents and neglecting losses in the rectifier components. Integrating the transformer voltage waveforms, fluxes in the core limbs are determined. It is shown that the fluxes contain a significant zero sequence component, resulting in a stray flux and high magnetizing currents. In the experiment, the magnetizing currents caused ringing zero sequence currents that degraded the rectifier efficiency. To control the stray flux and to reduce the magnetizing currents, either five limb core, shell type core, or three single phase cores should be applied. Application of three single phase cores is experimentally verified as an appropriate solution.

REFERENCES

- [1] M. Depenbrock, C. Niermann, "A new 12 pulse rectifier with line side interphase transformer and nearly sinusoidal line currents," Proceedings of the Power Electronics and Motion Control Conference, Budapest, 1990, pp. 374–378.
- [2] C. Niermann, "New rectifier circuits with low mains pollution and additional low cost inverter for energy recovery," Proceedings of the European Power Electronics Conference, Aachen, 1989, pp. 1131–1136.
- [3] M. Depenbrock, C. Niermann, "A new 18 pulse rectifier circuit with line side interphase transformer and nearly sinusoidal line currents," Proceedings of the 2nd International Power Electronics Conference (IPEC), Tokyo, 1990, pp. 539–546.
- [4] P. Mysiak, "A 24 pulse diode rectifier with coupled three phase reactor," Journal of the Chinese Institute of Engineers, Vol. 30, No. 7, pp. 1197–1212, 2007.
- [5] V. Caliskan, D. J. Perreault, T. M. Jahns, and J. G. Kassakian, "Analysis of three phase rectifiers with constant voltage loads," IEEE Trans. Circuits Syst. I, Fundam. Theory Appl., Vol. 50, No. 9, pp. 1220–1226, Sep. 2003.
- [6] P. Pejović, J. W. Kolar, "Exact analysis of three-phase rectifiers with constant voltage loads," IEEE Transactions on Circuits and Systems-II: Express Briefs, Vol. 55, No. 8, pp. 743–747, Aug. 2008.
- [7] P. Pejović, J. W. Kolar, "Analysis of a three phase twelve pulse voltage output type rectifier," submitted for review.
- [8] P. Pejović, J. W. Kolar, V. Šviković, "Sinusoidal Approximation in the Analysis of Twelve Pulse Output Voltage Type Rectifiers," 15th International Symposium of Power Electronics, Novi Sad, 2009.
- [9] P. Pejović, Three Phase Diode Rectifiers with Low Harmonics, Springer, 2007.